

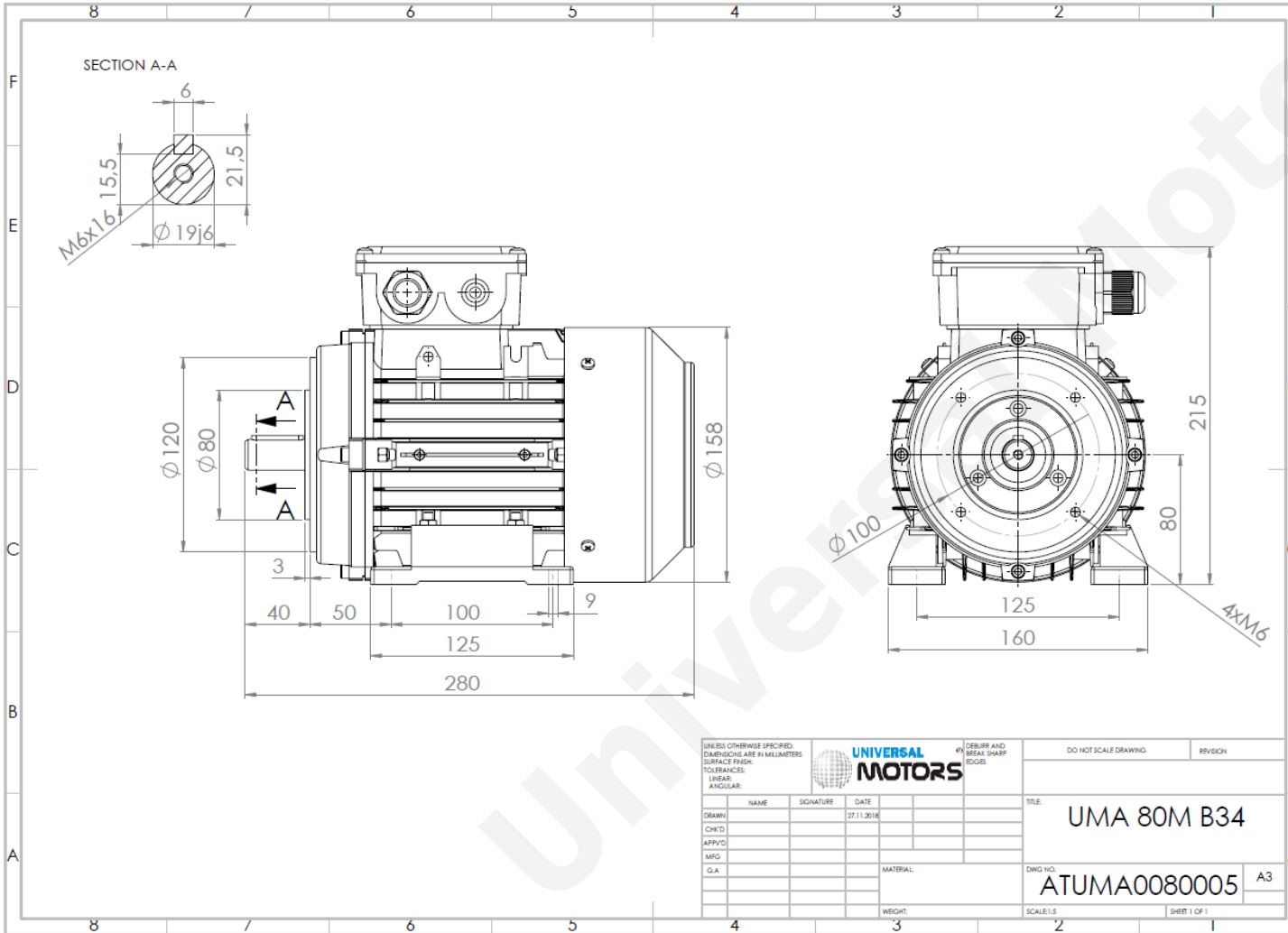

TECHNICAL DATA

Three Phase Electric Motors - Aluminum Frame
 UM2A 80M2-6
 0.55 kW / 0.75 Cv
 935 RPM



Motor type:	UM2A 80M2-6
Output:	0.55 kW / 0.75 Cv
Speed (min ⁻¹):	935 RPM
Frequency:	50 Hz
Voltage:	400 V
Current:	1.60 A
Power factor (Cos Ø):	0.68
Poles:	6
Insulation class:	F
Temperature rise Class:	B
Efficiency 50%:	69.7 %
Efficiency 75%:	71.6 %
Efficiency 100%:	73.1 %
Torque:	5.70 N.m
Tstarting/Tnominal:	2.0
Istarting/Inominal:	4.0
Tmaximum/Tnominal:	2.4
Noise:	56 Db(A)
Weight:	10.2 Kg
Brake AC:	AC3
Torque Brake DC:	8 N.m
Bearing DE:	6204 2Z
Bearing NDE:	6204 2Z
Torque Brake AC:	15 N.m
Brake DC:	REB-05-08

Regime - S1

Altitude - 1000m

Environment Temperature - 40°C

CONTACTS:

UNIVERSAL MOTORS Tel: +351 252 299 080
 Rua de São Brás,745 Fax: +351 252 299 089
 4480-782 VILA DO CONDE Mail: geral@universalmotors.pt

* References applied only in the UK